



OpenAir™

Air damper actuators

GMA...1

Rotary version with spring return, AC 24 V / AC 230 V

Electronic motor driven actuators for two-position, three-position, and modulating control, nominal torque 7 Nm, with spring return, self-centering shaft adapter, mechanically adjustable span between 0...90°, prewired with 0.9 m long connection cables.

Type-specific variations with adjustable offset and span for the positioning signal, position indicator, feedback potentiometer, self-adaptation of the rotary angle range, and adjustable auxiliary switches for supplementary functions.

Remarks

This data sheet provides a brief overview of these actuators. Please refer to the technical basics in CM2Z4614en for a detailed description as well as information on safety, engineering notes, mounting and commissioning.

Use

- For damper areas up to 1.5 m², friction-dependent.
- In ventilation sections where the actuator must move to the zero position (emergency position) during power failure.
- For dampers having two actuators on the same damper shaft (tandem-mounted actuators or Powerpack).

Type summary

GMA...	121.1E	126.1E	321.1E	326.1E	131.1E	132.1E	136.1E	161.1E	163.1E	164.1E	166.1E	191.1E	194.1E
Control type	Two-position control				Three-position control			Modulating control					
								Standard version			Enhanced vers.		
Operating voltage AC/DC 24 V	X	X			X	X	X	X	X	X	X	X	X
Operating voltage AC 230 V			X	X									
Positioning signal Y DC 0...10 V								X			X	X	X
DC 2...10 V												X	
DC 0...35 V with characteristic function $U_0, \Delta U$									X	X			X
Position indicator $U = DC 0...10 V$								X	X	X	X	X	X
Feedback potentiometer 1k Ω						X							
Self-adaptation of rotary angle range												X	X
Auxiliary switches (two)		X		X			X			X	X		X
Rotary direction switch												X	X
- Powerpack (2 actuators)	X	X	X	X	X	X	X					X	X
- Master/slave control												X	X

Functions

Type	GMA12..1 / GMA32..1	GMA13..1	GMA16..1 / GMA19..1
Control type	Two-position control	Three-position control	Modulating control
Positioning signal with adjustable characteristic function			DC 0...35 V at Offset $U_0 = 0...5 V$ Span $\Delta U = 2...30 V$
Rotary direction	Clockwise or counter-clockwise movement depends on the mounting position of the damper shaft... ...and on the type of control. <i>For GMA19..1 only:</i> ...and on the DIL switch setting that is either clockwise or counter-clockwise.		
Spring return	On power failure or when the operating voltage is switched off, the spring return moves the actuator to its mechanical zero position.		
Position indication: Mechanical	Rotary angle position indication by using a position indicator.		
Position indication: Electrical		The feedback potentiometer can be connected to external voltage to indicate the position.	Output voltage $U = DC 0...10 V$ is generated proportional to the rotary angle. <i>For GMA19..1 only:</i> U depends on the rotary direction of the DIL switch setting.
Auxiliary switch	The switching points for auxiliary switches A and B can be set independent of each other in increments of 5° within 5° to 90°.		
Self-adaptation of rotary angle range			<i>For GMA19...1 only:</i> When self-adaptation is active, the actuator automatically determines the mechanical end positions of the rotary angle range and maps the characteristic function ($U_0, \Delta U$) to the calculated rotary angle range.
Powerpack (two actuators, tandem-mounted)	Mounting two of the same actuator types on the same damper shaft may result in a double torque.		<i>Only for GMA19..1:</i> Parallel operation of the actuators by master/slave control.
Rotary angle limitation	The rotational angle of the shaft adapter can be limited mechanically at increments of 5°.		

Ordering

Note

Potentiometer and auxiliary switches **cannot be added in the field**. For this reason, order the type that includes the required options.

Delivery	Individual parts such as position indicator and other mounting materials for the actuator are not mounted on delivery.
Accessories, spare parts	Accessories to functionally extend the actuators are available, e.g., linear/rotary sets and weather protection cover; see data sheet N4697 .

Technical data

⚠ AC/DC 24 V supply (SELV/PELV)	Operating voltage AC / Frequency	AC 24 V ± 20 % / 50/60 Hz
	Operating voltage (DC)	DC 24 V ± 15 %
	Power consumption	GMA1...1: Running AC: 5 VA / 3.5 W // DC: 3.5 W GMA12..1, 13..1: Holding AC/DC: 2 W GMA16..1, 19..1: Holding AC/DC: 2.5 W
⚠ AC 230 V supply	Operating voltage / Frequency	AC 230 V ± 10 % / 50/ 60 Hz
	Power consumption	GMA32..1: Running 7 VA / 4.5 W Holding 3.5 W
	Function data	Nominal torque 7 Nm Maximum torque (blocked) 21 Nm Nominal rotary angle / Max. rotary angle 90° / 95° ± 2° Runtime for rotary angle 90° (motor operation) 90 s Closing time with return spring (on power failure) 15 s
Positioning signal for GMA13..1	Switching current (at AC/DC 24 V) for "Open"/"Close" (cores 6,7)	normally 8 mA
Positioning signal for GMA16..1, GMA19..1	Input voltage Y (wires 8-2)	DC 0...10 V / DC 2...10 V
	Max. permissible input voltage	DC 35 V
Characteristic functions for GMA161.1, 166.1, 191.1 for GMA163.1, 164.1, 194.1	Input voltage Y (wires 8-2)	DC 0...35 V
	Non-adjustable characteristic function	DC 0...10 V / DC 2...10 V
	Adjustable characteristic function	
	Offset U _o	DC 0...5 V
Position indicator for GMA16..1, 19..1	Span ΔU	DC 2...30 V
	Output voltage U (cores 9-2)	DC 0...10 V
	Max. output current	DC ± 1 mA
Feedback potentiometer for GMA132.1	Change of resistance (wires P1-P2)	0...1000 Ω
	Load	< 1 W
⚠ Auxiliary switch for GMA..6.1, 164.1, 194.1	Contact rating	6 A resistive, 2 A inductive
	Voltage (no mixed operation AC 24 V / AC 230 V)	AC 24...230 V
	Switching range for auxiliary switches / Setting increments	5°...90° / 5°
Connection cables	Cross-section	0.75 mm ²
	Standard length	0.9 m
Degree of protection of housing	Degree of protection as per EN 60 529 (note mounting instructions)	IP 54
Protection class	Insulation class	EN 60 730
	AC/DC 24 V, feedback potentiometer	III
	AC 230 V, auxiliary switch	II
Environmental conditions	Operation / Transport	IEC 721-3-3 / IEC 721-3-2
	Temperature	-32...+55 °C / -32...+70 °C
	Humidity (non-condensing)	< 95% r. h. / < 95% r. h.
Standards and directives	Product safety: Automatic electrical controls for household and similar use	EN 60 730-2-14 (Type 1)
	Electromagnetic compatibility (EMC):	
	Immunity for all models, except GMA132.1x	EN 61 000-6-2
	Immunity for GMA132.1x	EN 50 082-1
	Emissions for all models	EN 50 081-1
	☑ Conformity: Electromagnetic compatibility	89/336/EEC
	Low voltage directive	73/23/EEC
	☑ Conformity: Australian EMC Framework	Radio Communication Act 1992
Radio Interference Emission Standard	AS/NZS 3548	
Dimensions	Actuator W x H x D (see "Dimensions")	81 x 192 x 63 mm
	Damper shaft: Round / square	6.4...20.5 / 6.4...13 mm
	Min. shaft length	20 mm
Weight	Without packaging: GMA1..1 / GMA32..1	1.2 kg / 1.3 kg

Disposal

The document on technical basics and the environmental declaration provide information on environmental compatibility and disposal of this device.

Internal diagrams

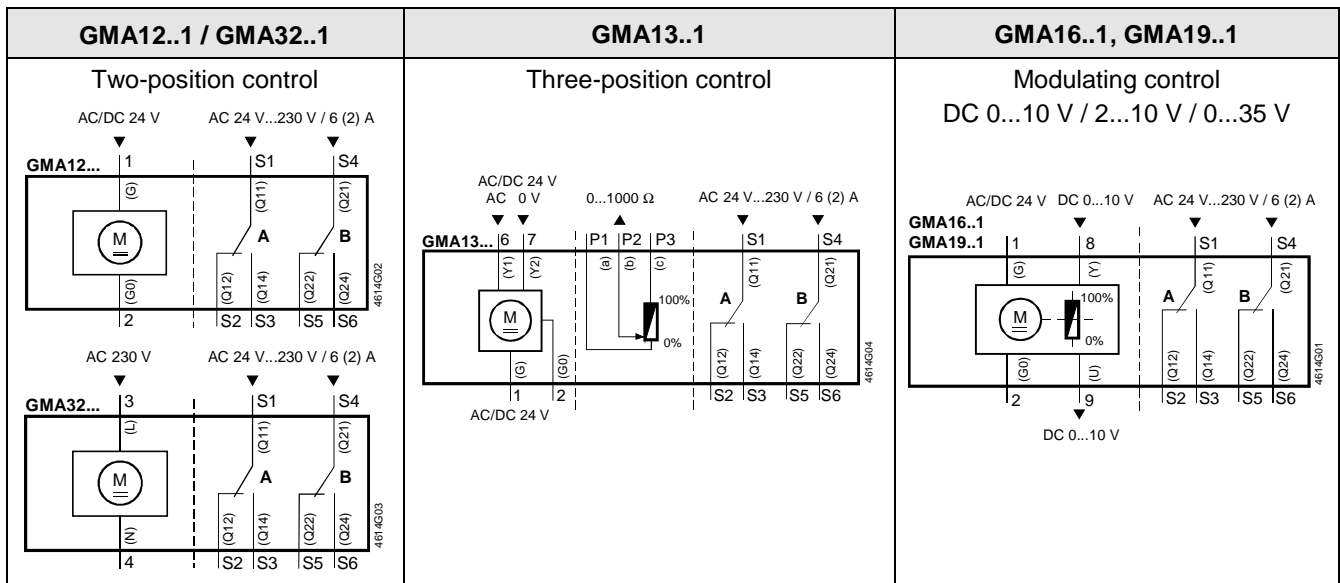

Cable labeling

Pin	Cable				Meaning
	Code	No.	Color Abbreviation		
Actuators AC 24V DC 24 V	G	1	red	RD	System potential AC/DC 24 V
	G0	2	black	BK	System neutral
	Y1	6	purple	VT	Pos. signal AC 0 V / AC/DC 24 V, open
	Y2	7	orange	OG	Pos. signal AC 0 V / AC/DC 24 V, close
	Y	8	gray	GY	Pos. signal DC 0...10 V, 2...10 V, 0...35 V
Actuators AC 230 V	L	3	brown	BR	Phase AC 230 V
	N	4	blue	BU	Neutral conductor
Auxiliary switch	Q11	S1	gray/red	GY RD	Switch A Input
	Q12	S2	gray/blue	GY BU	Switch A Normally closed contact
	Q14	S3	gray/pink	GY PK	Switch A Normally open contact
	Q21	S4	black/red	BK RD	Switch B Input
	Q22	S5	black/blue	BK BU	Switch B Normally closed contact
	Q24	S6	black/pink	BK PK	Switch B Normally open contact
Positioner	a	P1	white/red	WH RD	Potentiometer 0...100 % (P1-P2)
	b	P2	white/blue	WH BU	Potentiometer pick-off
	c	P3	white/pink	WH PK	Potentiometer 100...0 % (P3-P2)

Dimensions

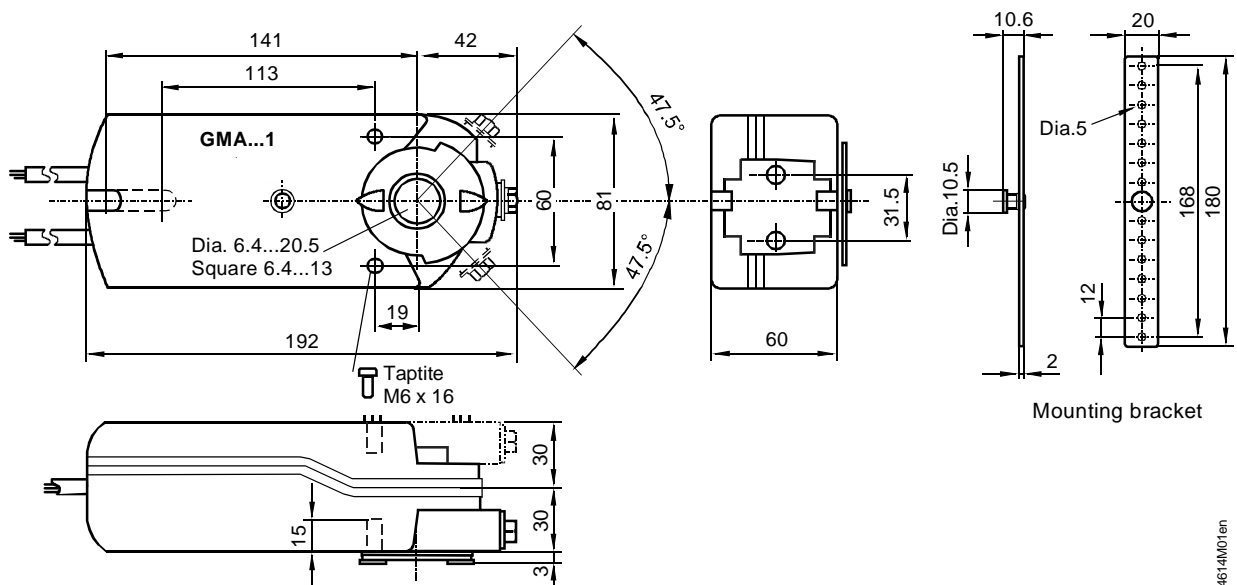

Dimensions in mm